



4 CHANNEL DELUXE TYPE MICROWAVE SENSOR

**MWS-ST-2 [TRANSMITTER]
MWS-SR-2 [RECEIVER]**

PAT. PEND.

**300% Increased Range!
Multi Channel type with
Received Power Level
Indicators.**



**100m/328ft range
with Ø27mm/1in antenna**

WADECO CO.,LTD.



Due to the sensor's high penetrability, surface contaminants and harsh environments do not affect its operation.

General

The MWS-ST/SR type microwave sensor is a level switch consisting of a transmitter (MWS-ST) and a receiver (MWS-SR) installed face-to-face. The transmitter emits a continuous, low power microwave beam towards the receiver and an output relay is released when the beam is obstructed. The sensor has wide application across all areas of industry where highly reliable, non-contact level detection is required. The sensor is generally used for process control by monitoring presence/absence of product, flow/no flow conditions and point level detection in chutes, bins and silos. The sensor may also be used as a proximity switch for detection of vehicles such as dump trucks and rail cars.

Features

• High penetration

Easily penetrates process buildup on antenna, firebrick, refractory etc., thanks to the increased operating range.

• Unaffected by adverse environments

The sensor is unaffected by surface contaminants, flames, steam, vapor or airborne particles.

• Simple beam alignment

Easy initial beam alignment at installation, due to the wide beam angle.

• Selectable detection mode

Either broken beam (BLOCK) or unbroken beam (UNBLOCK) detection method may be selected.

• No set-to-set interference

Four channels are available, selectable by rotary switch. This permits the use of multiple sets in close proximity to each other.

• Power level & sensitivity indicators

The received power level and the sensitivity-set-point are indicated on the receiver by a bank of 15 LEDs, allowing for easy visual adjustment and maintenance of the sensors.

• Analog output (optional)

The received power level may be output as an analog signal.

• Inspection window (optional)

The received power level and the sensitivity-set-point are easily seen, without removing the sensor's cover.

• Small sensing head (Ø27mm/1in)

Approximately 100m/328ft range with Ø27mm/1in antenna.

• Enclosure rating IP65/NEMA4 equivalent

Penetrability of microwaves

Harsh environments may result in a buildup of contaminants on the sensing head; however, the sensor is easily able to penetrate such buildup thanks to the high penetrability of microwaves.

When microwaves transmitted through air encounter an object, some will be reflected, some absorbed and the rest will pass through the object. The amount of microwaves passing through the object depends on its composition. Generally speaking, microwaves cannot penetrate metals and are reflected; water absorbs the most microwaves.

State-of-the-art Heterodyne Detection Method

The MWS-ST/SR level switch is the first of its kind to utilize the heterodyne detection method rather than the, now obsolete, diode detection method.

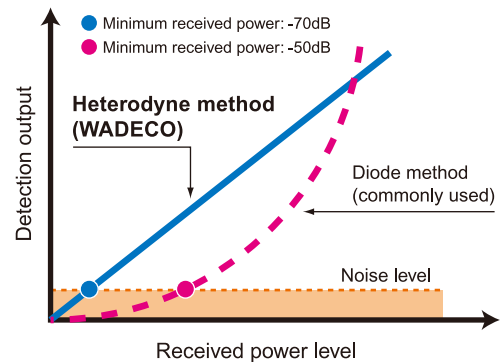

The heterodyne detection method gives detection output that is proportional to the received power level (*linear* function), whereas the diode detection method gives detection output that is proportional to the square of the received power level (*quadratic* function).

Therefore the heterodyne method allows detection with a minimum received power that is lower than that of the minimum level required by the diode detection method. This greatly increases the operating range/penetrability without any increase in the power of the transmitted microwave radiation.

Wiring

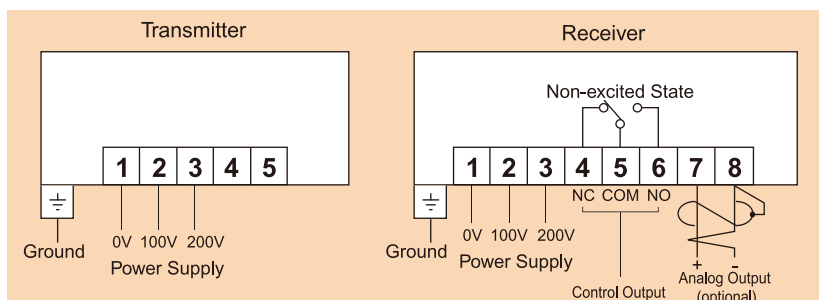

* Phase of power supply must be the same for both transmitter and receiver.

Selection of detection mode and relay configuration.

Detection mode	Beam broken BLOCK		Beam unbroken UNBLOCK		
	Terminal number	4 & 5	5 & 6	4 & 5	5 & 6
Unpowered state	Closed	Open	Closed	Open	Open
Powered state	Non-detecting state	Open	Closed	Open	Closed
	Detecting state	Closed	Open	Closed	Open

Function of Switches, Indicators and Rheostats

Transmitter

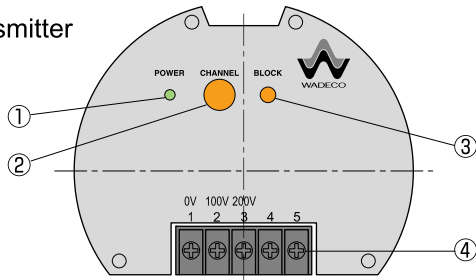

	Part Name	Description
①	Power indicator	Green when power is on
②	Channel selector	CH1~4 or CH0
③	Block button	Blocks transmission
④	Terminals	

Receiver

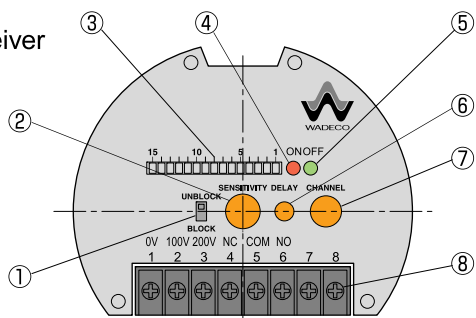

	Part Name	Description
①	Mode selection switch	BLOCK: Outputs on broken beam UNBLOCK: Outputs on unbroken beam
②	Sensitivity rheostat	For sensitivity adjustment
③	15 LED indicator array	Received power level: indicated by one of 15 LEDs Sensitivity set-point: indicated by one of 15 LEDs
④	Output indicator	ON (red): Illuminates on output
⑤	Output indicator	OFF (green): Illuminates on no output
⑥	On delay rheostat	0.1~10 sec.
⑦	Channel selector	CH1~4 or CH0
⑧	Terminals	

Selecting the channel

• Single channel mode (CH0)

In the case where multiple units are NOT installed in close proximity and a faster response time is desirable, the CHANNEL selector on both the transmitter ② and receiver ⑦ should be set to 0. Selecting CH0 will disable the multi channel function.

• Multi channel mode (CH1~4)

In the case where multiple sets of sensors are installed in close proximity to each other, multi channel mode should be used. The sensor comes standard with four channels (CH1~4). The CHANNEL selector on both the transmitter ② and its corresponding receiver ⑦ must be set to the same channel. Each pair of transmitters and receivers should be set to a different channel; if more than 4 channels are required consult WADECO or its representative.

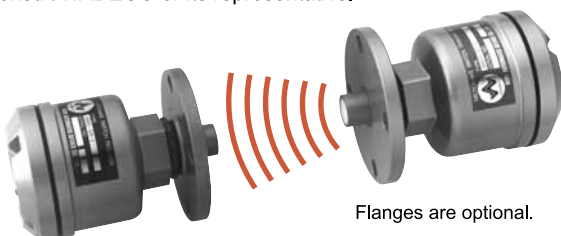

Sensitivity Adjustment

Before adjusting the sensitivity:

- Ensure that there is a clear line of sight between the transmitter and receiver.
- Set the CHANNEL selector on both the transmitter and receiver to 0 (single channel mode) if you are installing one transmitter/receiver set only; if you are installing more than one transmitter/receiver set, in close proximity, then select channel 1, 2, 3 or 4 (multi channel mode) to prevent set-to-set interference.
- The phase of the power supply must be the same for both the transmitter(s) and the receiver(s).

Transmitter MWS-ST-2

- Apply power to the unit. The green POWER indicator will illuminate.

Receiver MWS-SR-2

- Apply power to the unit. Either the red ON or the green OFF indicator will illuminate.
- Set the mode selection switch to BLOCK. Turn sensitivity rheostat fully counter clockwise (minimum).
- Turn the delay time rheostat fully counter clockwise (minimum).
- The red output indicator ON will illuminate.
- The sensitivity is adjusted visually using the 15 LED indicator array. The received power level and sensitivity-set-point are indicated on the receiver by a bank of 15 LEDs. Turn the sensitivity rheostat clockwise until the sensitivity-set-point is located halfway between the received power level in the BEAM UNOBSTRUCTED and the BEAM OBSTRUCTED states.

BEAM UNOBSTRUCTED

Received power level

Sensitivity-set-point

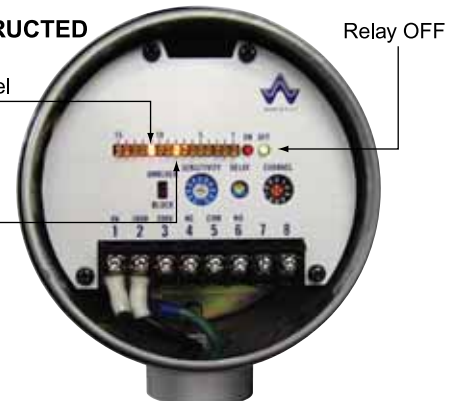

BEAM OBSTRUCTED

Received power level

Sensitivity-set-point

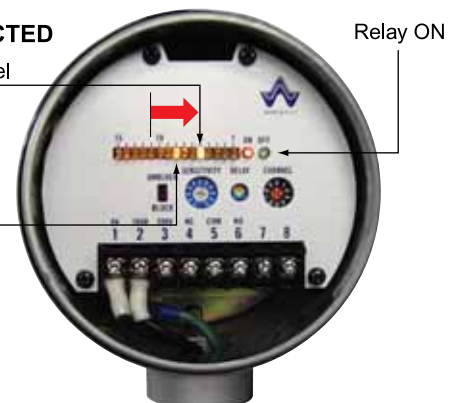

- For an application where material is introduced from above, a suitable delay time must be provided to avoid instantaneous detection of falling material.
- When adjusting the delay time, use the BLOCK button on the transmitter to simulate the beam being blocked.
- To use UNBLOCK output mode, switch the mode selection switch to UNBLOCK.

Specifications

	Transmitter	Receiver
Type	MWS-ST-2	MWS-SR-2
Power supply	AC100~120V or AC200~240V $\pm 10\%$, 50/60Hz	
Power consumption	2VA	2VA
*Operating distance	80m/262ft or less	
Frequency and transmission power	Approx. 24GHz, less than 10mW	
Compliance	FCC Title Rule 15 and OSHA exposure specification section 1910.97	
Number of channels	Single channel mode (CH0): 1, Multi channel mode (CH1~4): 4	
Received power level indication	Indicated by 1 of 15 LEDs	
Sensitivity-set-point indication	Indicated by 1 of 15 LEDs	
Radiation angle	Approx. $\pm 20^\circ$ (angle in half of receiving value)	
Output contact	1C relay contact AC250V, 2A ($\cos\theta=1$), relay is unexcited during output state	
Response time	10msec. (in single channel mode), 25msec. (in multi channel mode)	
On delay	0.1 ~ 10sec.	
Analog output (optional)	Load resistance 250 Ω max.	
Delay time from power on to function	Approx. 50msec.	
Noise tolerance	Square wave noise from noise simulator (rising time: 1 nanosecond, width: 1 microsecond), $\pm 1.5KV$ (normal and common modes), with the frequency of the power supply in the $0^\circ \sim 360^\circ$ phase.	
Operating ambient temperature	$-10^\circ C \sim +55^\circ C$ ($14^\circ F \sim 131^\circ F$)	
Non-function ambient temperature	$-20^\circ C \sim +70^\circ C$ ($-4^\circ F \sim 158^\circ F$)	
Continuous maximum pressure	0.5MPa	
Enclosure rating	IP65/NEMA4 equivalent	
Enclosure construction	Diecast aluminum	
Color	Metallic silver grey	
Weight	1kg (2.2lbs)	1kg (2.2lbs)

* The operating distance may vary from sensor to sensor and according to installation.

Installation

Install the transmitter and receiver face to face as shown below.

Both unit's cable entry should face in the same direction, or be 180° opposite each other.

Cable entry in the same direction.

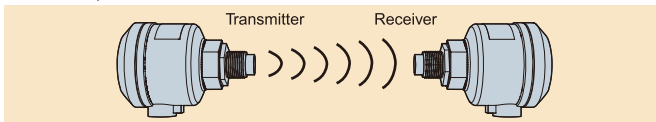

Cable entry 180° opposite each other.

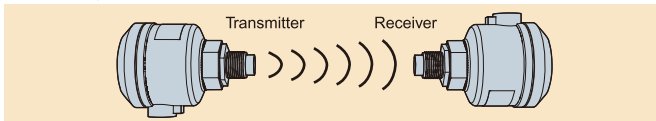

If the units are installed with cable entries at 90° to each other they will not function.

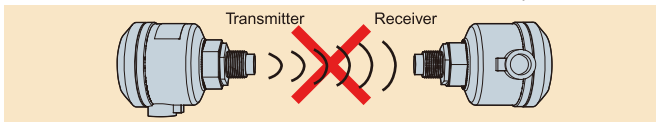

If two transmitter-receiver sets are installed in close proximity, different channels should be selected or one transmitter-receiver set should be mounted at a 90° angle to the other so that the waves of one unit will not interfere with the other's.

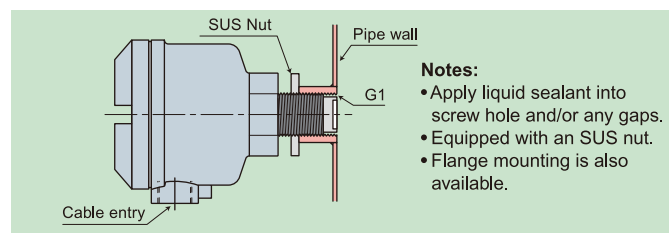
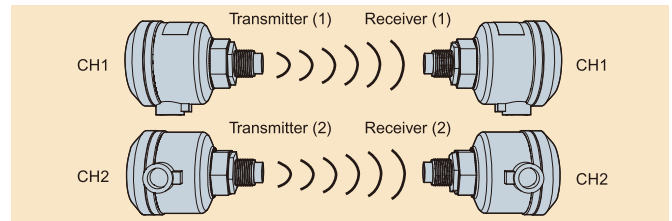

Dimensions

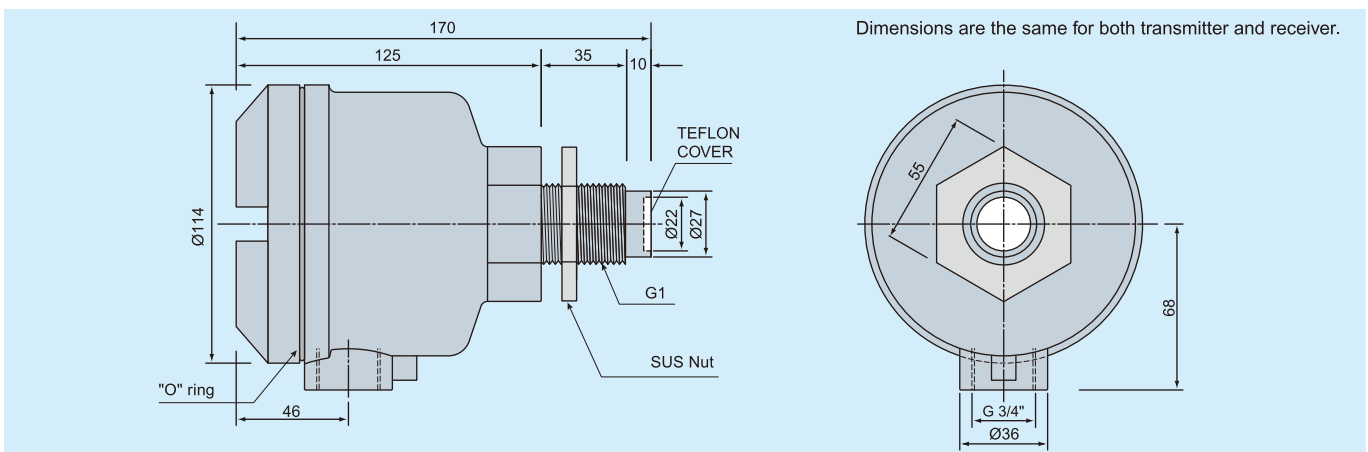

Specifications may be changed without notification.



WADECO CO.,LTD.

HEAD OFFICE WADECO Bld., 1-12-9, Meishin-cho, Amagasaki-shi,
Hyogo-ken 661-0021, Japan
TEL.+81-6-6482-3838 FAX.+81-6-6481-6321

TOKYO BRANCH 202 Shibuya-homes,2-1,Udagawa-cho,Shibuya-ku,Tokyo
150-0042,Japan
TEL.+81-3-3770-5519 FAX.+81-3-3770-5520

URL : <http://www.wadeco.co.jp>